

8568/MCCB-GS101B-50 Art. No. 240685



- Degree of protection: Flameproof 1- and 2-pole with thermal-magnetic branch circuit protection
- Rated operational current from 15 to 125 A
- Maximum rated operational voltage - IEC / ATEX up to 415 V AC and NEC / CEC up to 480 V AC
- 10 kA rated switching capacity IEC/EN 60947 / UL 489
- Isolating function to IEC/EN 60947-2
- Permanently set thermal and magnetic trips
- Design to UL 489 / CSA-C22.2 No. 5 & IEC 60947-2

MY R. STAHL 8568A



Series 8568 molded-case circuit breakers meet all technical requirements relating to safe and selective tripping. When short-circuits occur, they restrict the load on the installed circuits due to their excellent current limiting and related high breaking capacity and provide a high level of discrimination for line-side fuses.

Technical Data

Explosion Protection

Application range (Zones)	1 2 21 22
Application range (Zone) note	Can be used in Zone 21 / 22 with protection by installation in enclosure Ex tb / tc
IECEx gas certificate	FMG16.0005X
IECEx gas explosion protection	Ex db eb IIC T4 / T6 Gb
ATEX gas certificate	FM 16 ATEX 0005X
ATEX gas explosion protection	Ⓔ II 2 G Ex db eb IIC T4 / T6 Gb
FMus certificate	FM19US0099U
cFM certificate	FM19CA0049U
Marking FMus	Class I, Div. 2, Groups A,B,C,D; T6 ... T4, Class I, Zone 1, AEx db eb IIC T6 ... T4
Marking cFM	Class I, Zone 1, Ex db eb IIC T6 ... T4 Class I, Div. 2, Groups A,B,C,D; T6 ... T4
Certificates	ATEX (FM), Canada (FM), IECEx (FM), USA (FM)

Electrical Data

Rated operational voltage AC	240 V
Rated operational voltage AC (NEC)	347 V
Rated operational voltage DC	125 V
Rated operational voltage DC (NEC)	125 V
Rated operational current	50 A
Rated interrupting capacity	10 kA
Type of voltage	AC/DC
Auxiliary contacts	without
Auxiliary contacts 2	without
N-pole present	No
No. of poles	1

8568/MCCB-GS101B-50 Art. No. 240685

Ambient Conditions

Ambient temperature °C	-30 °C ... +40 °C (T6) -30°C ... +60°C (T4)
Ambient temperature °F	-22 °F ... +104 °F (T6) -22 °F ... +140 °F (T4)
Note	Ambient temperature range for the location of the equipment installation. For installation up to +60 °C (+140 °F), consult the factory.

Mechanical Data

Degree of protection (IP)	IP20
Enclosure material	Epoxy resin
Connection cross-section AWG	10 AWG ... 1/0 AWG
Connection cross-section	6 ... 50 mm ²
Width	63.8 mm
Width in inches	2.51 in
Length	286 mm
Length, inches	11.26 in
Depth of cut-out	144 mm
Mounting depth, inches	5.67 in
Weight	2.35 kg
Weight	5.18 lb

Mounting / Installation

Tightening torque	6 – 8 Nm
Tightening torque lbf in	53 to 71 lbf in

Dimensional Drawings (All Dimensions in mm [inches]) – Subject to Alterations

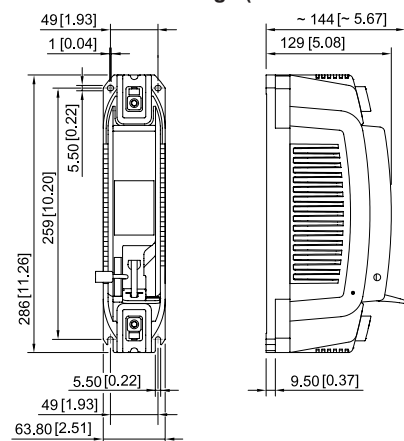

8568/MCCB, 1-pole

We reserve the right to make alterations to the technical data, dimensions, weights, designs and products available without notice. The illustrations cannot be considered binding.